

Sail Sign Universal Assembly Instruction Sheet

Products these steps apply to:

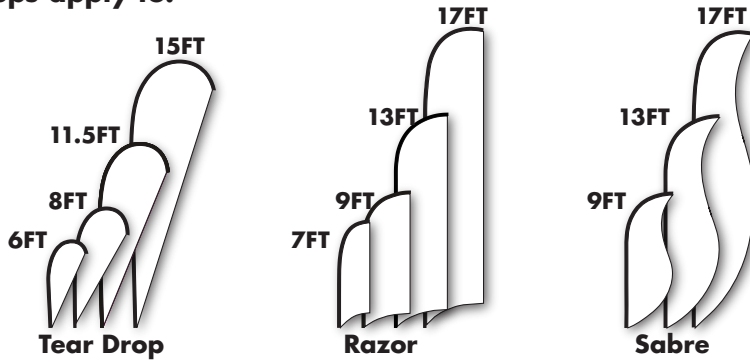

NOTE: Keep product clear from trees, poles, buildings, or any other obstruction as it will cause premature wear.

Product Parts

1 - Graphic
 2 - Poles (as shown)
 3 - 190712 Elastic Cord Kit includes: A-Elastic Cord, B-Ring, C-Clip

Optional Parts

4- Base (options a/b/c)
 a. Spike
 b. Scissor
 c. Indoor 3-leg
 5 - Water Ballast (round/square)

Diagram 2: Shows poles for 6' Teardrop (2 poles: Bottom Pole, Top Pole) and 15' and 17' (4 poles: Bottom Pole, Middle Pole, Middle Pole 2, Top Pole).

Diagram 3: Shows the Elastic Cord Kit (A, B, C) and base options (4a, 4b, 4c).

Diagram 5: Shows a water ballast (5).

Display Set-Up

Step 1

Begin by removing the parts from the carry case and placing them on a clean flat surface.

Assemble the Poles (2) together by inserting the Bottom Pole into the Middle Pole.



Step 2

Insert the Top Pole into the Middle Pole. **NOTE:** for 15' and/or 17' Sail Signs you will have 2 Middle Poles to insert together before inserting the Top Pole.



Step 3

Carefully insert the top end of the assembled Poles (2) into the pole pocket of the Fabric Graphic (1). Push the Pole (2) as far as it will go until it hits the end of the pole pocket. **DO NOT FORCEFULLY PUSH THE POLE OR IT COULD SNAP.**



Step 4

Remove the Ring (B) from the Clip (C) on the Elastic Cord Kit (3). Connect the Ring (B) to the webbing loop on the bottom end of your Fabric Graphic Pole Pockets (1).

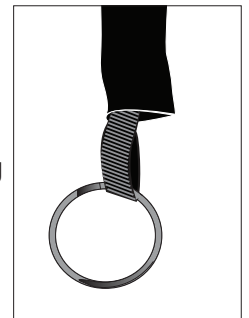

Display Set-Up Continued...

Step 5

Put one end of the Elastic Cord (A) through the Clip's (C) ring. Attach Clip (C) to the Ring (B)

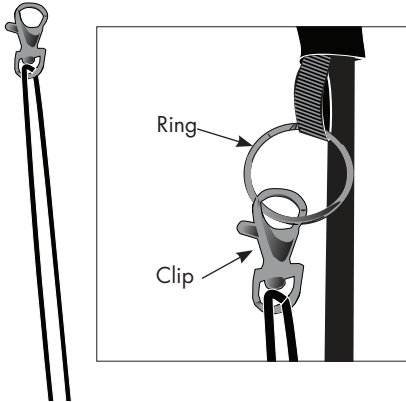

Step 6

Using the Elastic Cord (A) pull down the Fabric Graphic on the pole to create the desired shape. Knot the end of elastic Cord (A) and secure under the plastic Pole Hook located on the base of the Bottom Pole (2)

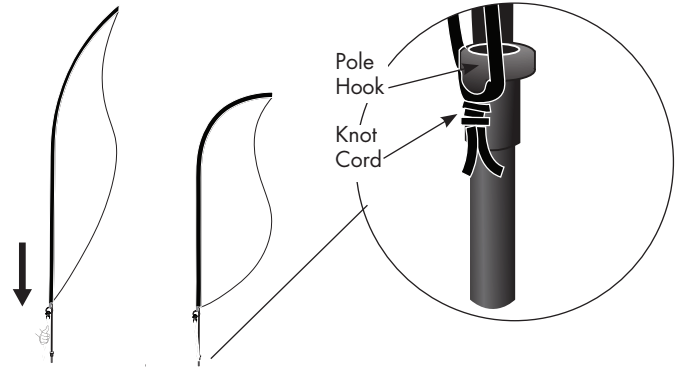

Optional Base Spike 4a

Hammer Spike Base (4a) into the ground at desired location. **DO NOT** hammer the shorter post. Insert Bottom of Pole (2) over stem on Spike Base (4a).

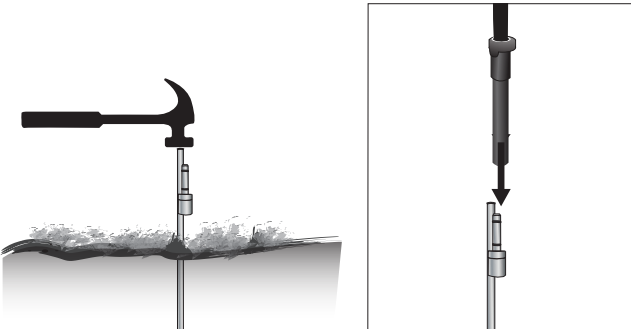

Optional Base Scissors 4b

Place Scissors Base (4b) at desired location by extending the legs outward. Insert the bottom of the Sail Sign over the Scissor Base (4b) stem.

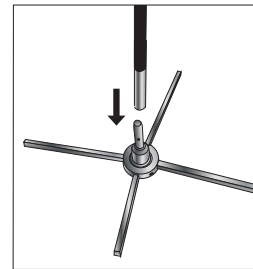

Optional Base Indoor 3-leg 4c

Set up the 3 Leg Base (4) by screwing in each leg to the center stem. Insert the bottom of the Sail Sign over the 3 Leg Base (4c) stem. This base fits only 6FT/7FT sails.

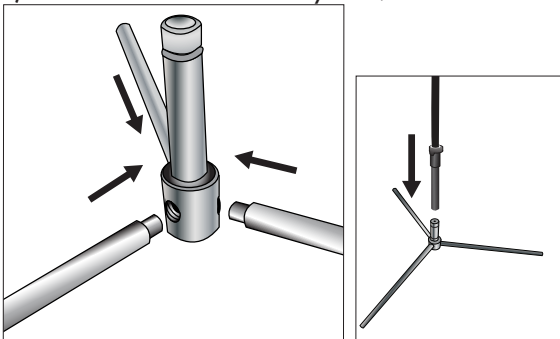

Optional Water Ballast

Place the Water Ballast (5) over the Base (4) **BEFORE** attaching the Sail Sign. Fill Water Ballast (5) with water for stability.

NOTE: 15' and 17' sails signs will need square water ballasts



Storage and Care

Place all product parts into Carry Case and store in a cool dry location, away from direct sunlight. To clean, wipe with damp cloth. Do not iron or dry clean the banner.

